











	Model	TopTech32-23D.4
	Code Production	LP423CDDD
Interface :		
		
		

	Overall Dimension (Width-Depth-Height) *open	mm	719 x 782(*1180)x1727(*1997)
	Packaging Dimension (WxDxH)	mm	870x890x2200
	Gross weight	Kg	157
	Net weight	Kg	148
	Volume	mc	1,70
	Rack size	mm	560x630
	Max door /hood opening	mm	650
	Max glasses/plate Height	mm	600
	General construction		double skin
	Door/hood Construction		double skin
	Tank construction		fully deep drawn
	Tank volume	liter	37
	Tank heating element	W	3.000
	Tank surface strainers		stainless steel
	Wash pump type		double flow
	Wash pump power	W	1.500
	Wash temperature	°C	55 (55-65)
	Boiler type		without pressure
	Boiler volume	liter	12
	Back-flow system		break tank
	Boiler heating element	W	6.000
	Rinse booster pump		YES
	Rinse booster pump power	W	200
	Rinse temperature	°C	80 (80-85)
	Rinse water consumption	Liter /rack	3
	Optimal external water pressure	bar	1 - 6
	Drain system		deep drain
	Drain filter		double filter
	Drain pump		standard built in
	Rinse aid dispenser		YES
	Detergent dispenser		YES
	Wash cycle	sec	120 - 240 - 360 - 720
	Special cycle	programs	n°6
	Self cleaning cycle		YES
	Electric Power	W	10.500
	Electric Connection	V - ph - Hz	400V 3N 50Hz
	Fuse	A	20
	Steel generic basket	N°1	41305
	Electric cable		YES
	Drain hose		YES
	Fill hose		YES

A		∅ 50mm M	A EXIT	∅ 35 mm M
B		G 3/4" M	B EXIT	G 3/4" F
C		Power supply	E	Steam exhaust

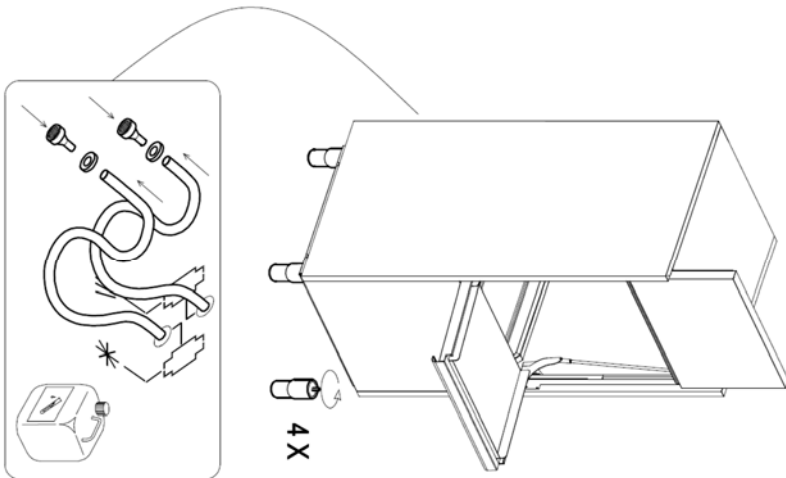
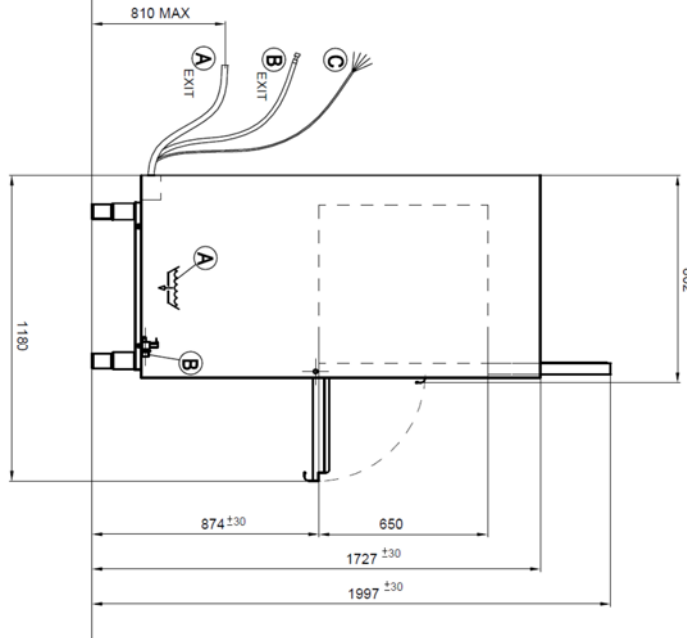
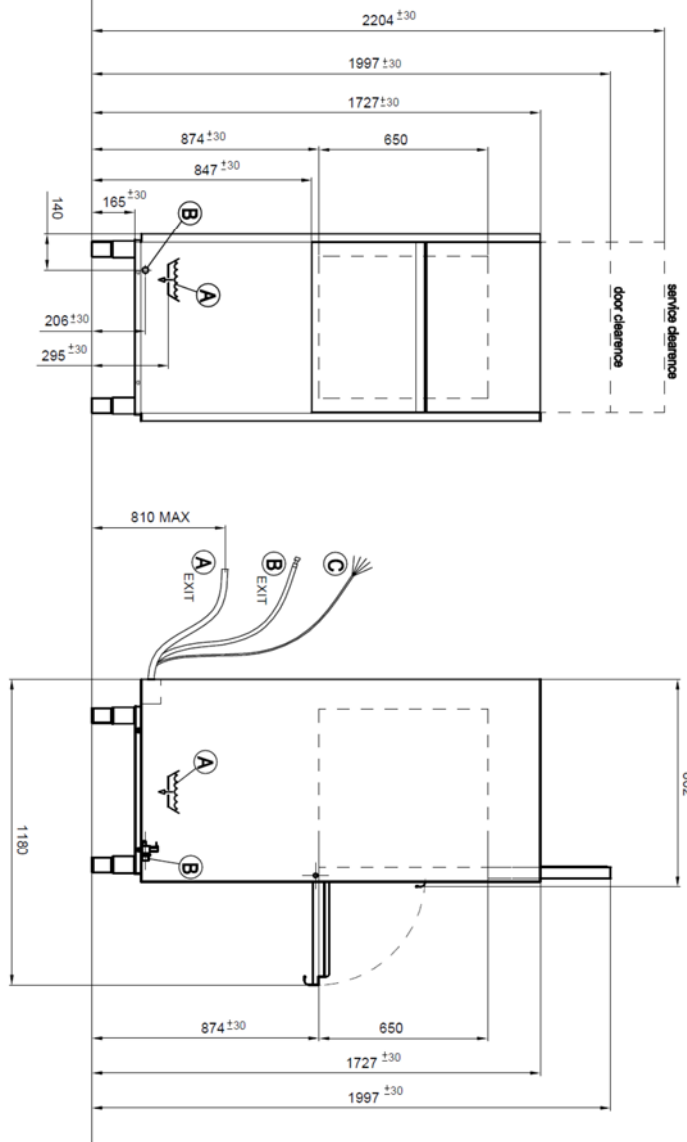
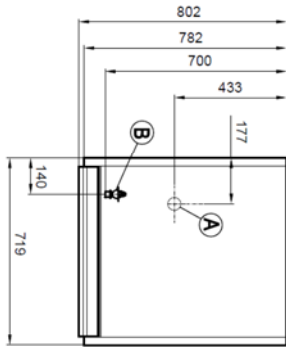

Installation layout		Utensil washer with Drain Pump	
Designed by:	M.P.FERRI	Date:	05.10.2018
Code:	LP4	Rev.:	00